



# URBAN MARKET

COLLECTION

 **Cayuga** DISPLAYS



# BUILD YOUR OWN CASE

**Cayuga understands product merchandising today is about fresh presentation, versatility and innovation – often in smaller retail spaces. Retailer needs can be very specific, however budgets don't always allow for a fully custom case. This is where the Urban Market Collection comes in: customizable cases designed on a standard platform.**

The Urban Market Collection reflects the latest styles and trends in the industry – helping you keep your look and brand fresh. Designed and manufactured at our own North American facility, the entire collection is fully customizable with a variety of finishes, colours, materials and other options.

And when you work with Cayuga Displays, you can always be confident we'll help you to select the right product and options, so that you have the food presentation that is certain to elevate your customers' experience and enhance your brand – beautifully.

*“Longo's is pleased to support Cayuga Displays. Your team's quick service/turnaround for projects has helped us with our millwork for bakery and floral in past projects. More recently your team has come up with some cost effective refrigeration solutions for our bakery and produce.”*

Paul Collette,  
Longo's Support Center  
Project Manager Real Estate  
and Construction

# CURVED GLASS COMBINATION SERVICE/ SELF-SERVICE DISPLAY

 REFRIGERATED

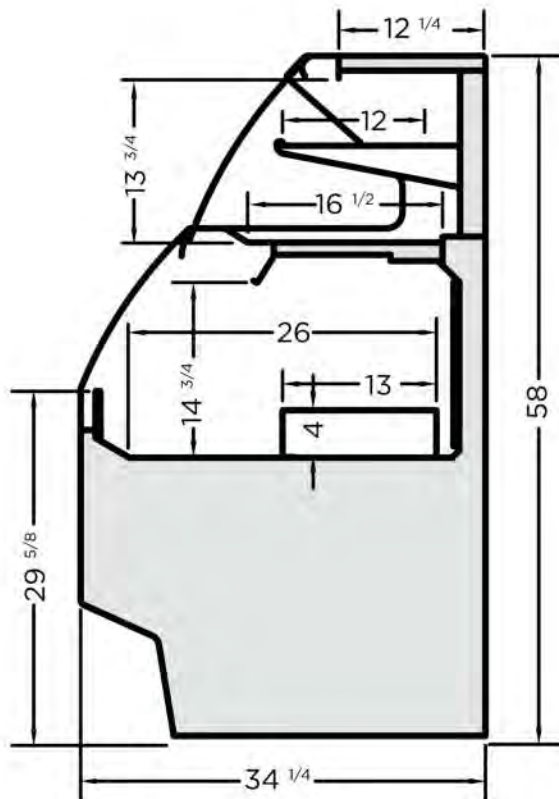

MODEL	LENGTH
SSS-38	40 1/4"
SSS-48	49 7/8"
SSS-57	59 3/8"
SSS-76	78 1/2"

## FEATURES:

- Outfitted with a sliding baffle between the upper and lower levels to allow the upper section to be used for either refrigerated or dry merchandising
- 3 interior finishes available
- Many exterior colors, patterns and wood grain finishes available
- R-134A self-contained refrigeration
- 1 adjustable tempered glass shelf in the top service display area
- Tilt-out front glass on the top display area for easy cleaning
- Stepped riser in the base self-service display area (shelf options available)
- Removable base deck panels for easy cleaning and service
- LED lighting attached to the top ledge of the service and the self-service display
- Thermal rear sliding doors at the back of the top service display
- Many options available. Refer to the options schedule on next page

## SUGGESTED APPLICATIONS:

-  Bakery
-  Restaurants
-  Deli
-  Cafe

Note: Information and specifications may change due to engineering improvements.



# CURVED GLASS COMBINATION SERVICE/ SELF-SERVICE DISPLAY

 REFRIGERATED

ELECTRICAL SPECS					
MODEL	LENGTH	VOLTS	AMPS	NEMA	
SSS-38	40 ¼"	115	11.6	5-15P	
SSS-48	49 ⅞"	115	11.9	5-15P	
SSS-57	59 ⅜"	115/230	8.8	L14-20P	
SSS-76	78 ½"	115/230	9.8	L14-20P	

INTERIOR FINISH	
Brushed Stainless Steel Base inlay with textured black shelf standards and shelf supports	
Textured Black	
Textured White	

EXTERIOR FINISHES	
Category "A" laminate finish: <b>A</b> - ____	
Category "B" laminate finish: <b>B</b> - ____	
Other custom laminate specs:	
Brushed Stainless Steel	
Oak Veneer Plywood	
- Vertical grain direction	
- Horizontal grain direction	
Birch/Maple Veneer Plywood	
- Vertical grain direction	
- Horizontal grain direction	
Clear Finish applied to veneer	
Stain Finish Choice _____	
1" black McCue impact bumper strip applied to the front of the display	
Other McCue impact bumper strip colors Available upon request	

END PANELS	
Interior laminate the same as exterior	
Black interior	
White interior	
Brushed Stainless Steel interior	
Mirrored interior	
Mirrored end panel glass	
- Black T-mold edging	
- White T-mold edging	
- Stainless Steel T-mold edging	
1" black McCue impact bumper strip applied to the outside of the end panel	
Other McCue impact bumper strip colors available upon request	

MISCELLANEOUS	
Roll-down thermal night curtain	
Heavy duty lockable casters	
Rear fold-down work shelf	
Add 1 shelf level to the bottom self-service display area (instead of stepped inlay)	
Mirrored rear sliding doors	
Locks for rear sliding doors	
Wire security grill panel for service display area	

## ADDITIONAL FEATURES:

- Designed to maintain product temperature of 38-41°F with a maximum ambient atmosphere of 75°F/55% humidity
- Hot gas condensate evaporation system
- ETL Listed and Sanitation certified to NSF 7
- 2 Year Parts & Labour Warranty
- Rear air intake, front discharge. Avoid any obstructions in these areas

# SLIM-LINE COMBINATION SERVICE/ SELF-SERVICE DISPLAY

REFRIGERATED

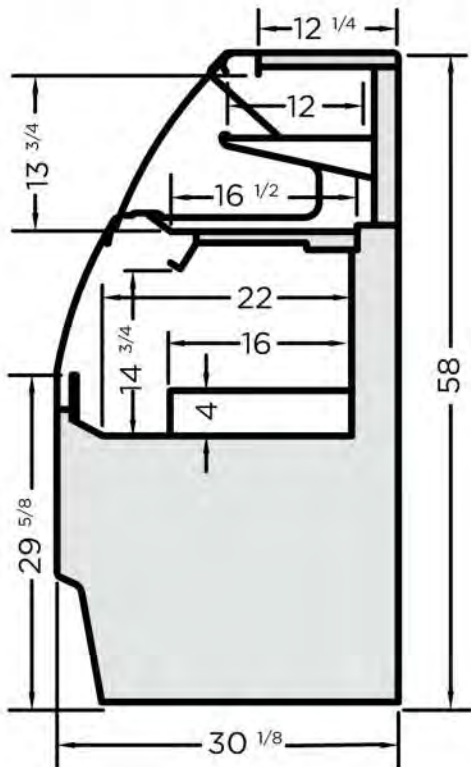

MODEL	LENGTH
SLS-38	40 1/4"
SLS-48	49 3/8"
SLS-57	59 3/8"
SLS-76	78 1/2"

## FEATURES:

- 3 interior finishes available
- Many exterior colors, patterns and wood grain finishes available
- R-134A self-contained refrigeration
- Sliding baffle between the service/self-service sections to create a dry service display
- 1 adjustable tempered glass shelf in the top service display area
- Tilt-out front glass on the top display area for easy cleaning
- Stepped riser in the base self-service display area (shelf options available)
- Removable base deck panels for easy cleaning and service
- LED lighting attached to the top ledge of the service and the self-service display
- Thermal rear sliding doors at the back of the top service display
- Many options available. Refer to the options schedule on next page

## SUGGESTED APPLICATIONS:



Bakery



Restaurants



Deli



Cafe

Note: Information and specifications may change due to engineering improvements.



## SLIM-LINE COMBINATION SERVICE/ SELF-SERVICE DISPLAY

 REFRIGERATED

### ELECTRICAL SPECS

MODEL	LENGTH	VOLTS	AMPS	NEMA	
SLS-38	40 ¼"	115	11.6	5-15P	
SLS-48	49 ⅞"	115	11.9	5-15P	
SLS-57	59 ⅜"	115/230	8.8	L14-20P	
SLS-76	78 ½"	115/230	9.5	L14-20P	

### INTERIOR FINISH

Brushed Stainless Steel base inlay with textured black shelf standards and shelf supports	
Textured Black	
Textured White	

### EXTERIOR FINISHES

Category "A" laminate finish: <b>A-</b> ____	
Category "B" laminate finish: <b>B-</b> ____	
Other custom laminate specs:	
Brushed Stainless Steel	
Oak Veneer Plywood	
- Vertical grain direction	
- Horizontal grain direction	
Birch/Maple Veneer Plywood	
- Vertical grain direction	
- Horizontal grain direction	
Clear Finish applied to Veneer	
Stain Finish Choice _____	
1" black McCue impact bumper strip applied to the front of the display	
Other McCue impact bumper strip colors Available upon request	

### END PANELS

Interior laminate the same as exterior	
Black interior	
White interior	
Brushed Stainless Steel interior	
Mirrored interior	
Mirrored end panel glass	
- Black T-mold edging	
- White T-mold edging	
- Stainless Steel T-mold edging	
1" black McCue impact bumper strip applied to the outside of the end panel	
Other McCue impact bumper strip colors available upon request	

### MISCELLANEOUS

Roll-down thermal night curtain	
Heavy duty lockable casters	
Rear fold-down work shelf	
Stepped inlay for bottom area instead of shelf	
Mirrored rear sliding doors	
Locks for rear sliding doors	
Wire security grill panel for service display area	

### ADDITIONAL FEATURES:

- Designed to maintain product temperature of 38-41°F with a maximum ambient atmosphere of 75°F/55% humidity
- Hot gas condensate evaporation system
- ETL Listed and Sanitation certified to NSF 7
- 2 Year Parts & Labour Warranty
- Rear air intake, front discharge. Avoid any obstructions in these areas

# SERVICE DISPLAY

REFRIGERATED

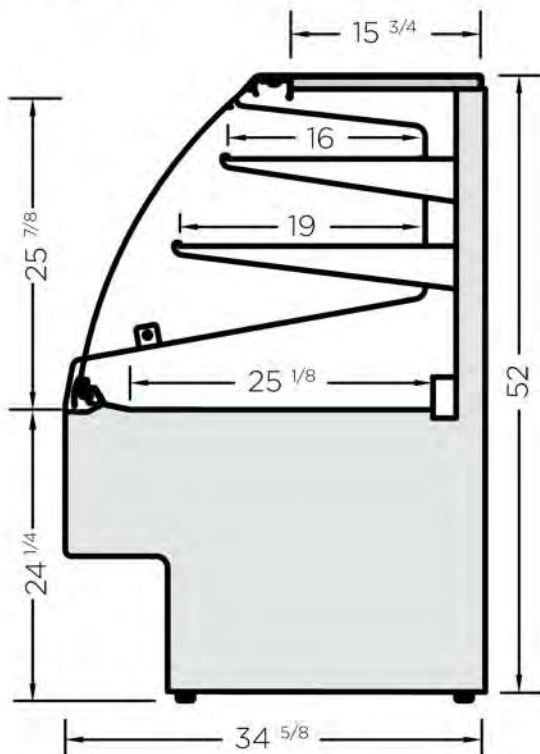





MODEL	LENGTH
RH3-38	40 1/4"
RH3-48	49 7/8"
RH3-57	59 3/8"
RH3-76	78 1/2"
RH3-96	97 5/8"

## FEATURES:

- 3 interior finishes available
- Many exterior colors, patterns and wood grain finishes available
- R-134A self-contained refrigeration
- 2 adjustable tempered glass shelves with integrated LED lighting
- Removable base deck panels for easy cleaning and service
- Air circulating defogging system to keep the front glass clear of condensation
- Tilt-out front glass for easy cleaning
- LED lighting attached to the top ledge of the display
- Thermal rear sliding doors
- Many options available. Refer to the options schedule on next page

## SUGGESTED APPLICATIONS:

-  Bakery
-  Restaurants
-  Deli
-  Butcher shops
-  Cafe

Note: information and specifications may change due to engineering improvements.



# SERVICE DISPLAY

 REFRIGERATED

ELECTRICAL SPECS					
MODEL	LENGTH	VOLTS	AMPS	NEMA	
RH3-38	40 ¼"	115	9.1	5-15P	
RH3-48	49 ⅞"	115	12.3	5-20P	
RH3-57	59 ⅜"	115	13	5-20P	
RH3-76	78 ½"	115/230	9.8	L14-20P	
RH3-96	97 ⅝"	115/230	10.3	L14-20P	

INTERIOR FINISH	
Brushed Stainless Steel base inlay with textured black shelf standards and shelf supports	
Textured Black	
Textured White	

EXTERIOR FINISHES	
Category "A" laminate finish: <b>A-</b> ____	
Category "B" laminate finish: <b>B-</b> ____	
Other custom laminate specs:	
Brushed Stainless Steel	
Oak Veneer Plywood	
- Vertical grain direction	
- Horizontal grain direction	
Birch/Maple Veneer Plywood	
- Vertical grain direction	
- Horizontal grain direction	
Clear Finish applied to veneer	
Stain Finish Choice _____	
1" black McCue impact bumper strip applied to the front of the display	
Other McCue impact bumper strip colors Available upon request	

END PANELS	
Solid	
- LH (visualized from the front)	
- RH (visualized from the front)	
Contoured Tempered Glass	
- LH (visualized from the front)	
- RH (visualized from the front)	
Interior laminate the same as exterior	
Black interior	
White interior	
Brushed Stainless Steel interior	
Mirrored interior	
Mirrored end panel glass	
- Black T-mold edging	
- White T-mold edging	
- Stainless Steel T-mold edging	
1" black McCue impact bumper strip applied to the outside of the end panel	
Other McCue impact bumper strip colors available upon request	

MISCELLANEOUS	
Heavy duty lockable casters	
Rear fold-down work shelf	
Add one shelf level (with LED light strip)	
Eliminate 1 shelf level	
Mirror rear sliding doors	
Locks for rear sliding doors	

## ADDITIONAL FEATURES:

- Designed to maintain product temperature of 38-41°F with a maximum ambient atmosphere of 75°F/55% humidity
- Hot gas condensate evaporation system
- ETL Listed and Sanitation certified to NSF 7
- 2 Year Parts & Labour Warranty
- Rear air intake, front discharge. Avoid any obstructions in these areas



# SERVICE DISPLAY

□ AMBIENT

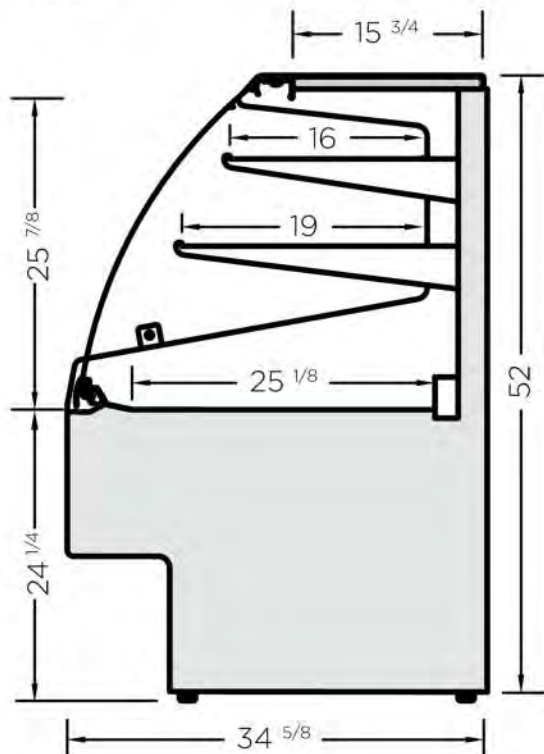





MODEL	LENGTH
DH3-38	40 1/4"
DH3-48	49 3/8"
DH3-57	59 3/8"
DH3-76	78 1/2"
DH3-96	97 5/8"

## FEATURES:

- 3 interior finishes available
- Many exterior colors, patterns and wood grain finishes available
- 2 adjustable tempered glass shelves with integrated LED lighting
- Removable base deck panels for easy cleaning and service
- Tilt-out front glass for easy cleaning
- LED lighting attached to the top ledge of the display
- Rear sliding doors
- Many options available. Refer to the options schedule on next page

## SUGGESTED APPLICATIONS:

-  Bakery
-  Restaurants
-  Deli
-  Butcher shops
-  Cafe

Note: Information and specifications may change due to engineering improvements.



## SERVICE DISPLAY

□ AMBIENT

### ELECTRICAL SPECS

MODEL	LENGTH	VOLTS	AMPS	NEMA	
DH3-38	40 ¼"	115	.5	5-15P	
DH3-48	49 ⅞"	115	.5	5-15P	
DH3-57	59 ⅜"	115	1.0	5-15P	
DH3-76	78 ½"	115	1.0	5-15P	
DH3-96	97 ⅝"	115	1.0	5-15P	

### INTERIOR FINISH

Brushed Stainless Steel base inlay with textured black shelf standards and shelf supports	
Textured Black	
Textured White	

### EXTERIOR FINISHES

Category "A" laminate finish: <b>A-</b> ____	
Category "B" laminate finish: <b>B-</b> ____	
Other custom laminate specs:	
Brushed Stainless Steel	
Oak Veneer Plywood	
- Vertical grain direction	
- Horizontal grain direction	
Birch/Maple Veneer Plywood	
- Vertical grain direction	
- Horizontal grain direction	
Clear Finish applied to Veneer	
Stain Finish Choice _____	
1" black McCue impact bumper strip applied to the front of the display	
Other McCue impact bumper strip colors Available upon request	

### ADDITIONAL FEATURES:

- ETL Listed and Sanitation certified to NSF 7
- 2 Year Parts & Labour Warranty

### END PANELS

Solid	
- LH (visualized from the front)	
- RH (visualized from the front)	
Contoured Tempered Glass	
- LH (visualized from the front)	
- RH (visualized from the front)	
Interior laminate the same as exterior	
Black interior	
White interior	
Brushed Stainless Steel interior	
Mirrored interior	
Mirrored end panel glass	
- Black T-mold edging	
- White T-mold edging	
- Stainless Steel T-mold edging	
1" black McCue impact bumper strip applied to the outside of the end panel	
Other McCue impact bumper strip colors available upon request	

### MISCELLANEOUS

Heavy duty lockable casters	
Rear fold-down work shelf	
Add 1 shelf level (with LED light strip)	
Eliminate 1 shelf level	
Mirrored rear sliding doors	
Locks for rear sliding doors	

# SELF-SERVICE DISPLAY - 52" H

 REFRIGERATED



MODEL	LENGTH
RSS-38-52	40 1/4"
RSS-48-52	49 7/8"
RSS-57-52	59 3/8"
RSS-76-52	78 1/2"
RSS-96-52	97 5/8"

## FEATURES:

- 3 interior finishes available
- Many exterior colors, patterns and wood grain finishes available
- R-134A self-contained refrigeration
- 2 adjustable tempered glass shelves with integrated LED lighting
- Removable base deck panels for easy cleaning and service
- LED lighting attached to the top ledge of the display
- Many options available. Refer to the options schedule on next page

## SUGGESTED APPLICATIONS:

- |   |   |
|---|---|
|  Bakery |  Restaurants   |
|  Deli   |  Butcher shops |
|  Cafe   |  Produce       |

Note: Information and specifications may change due to engineering improvements.

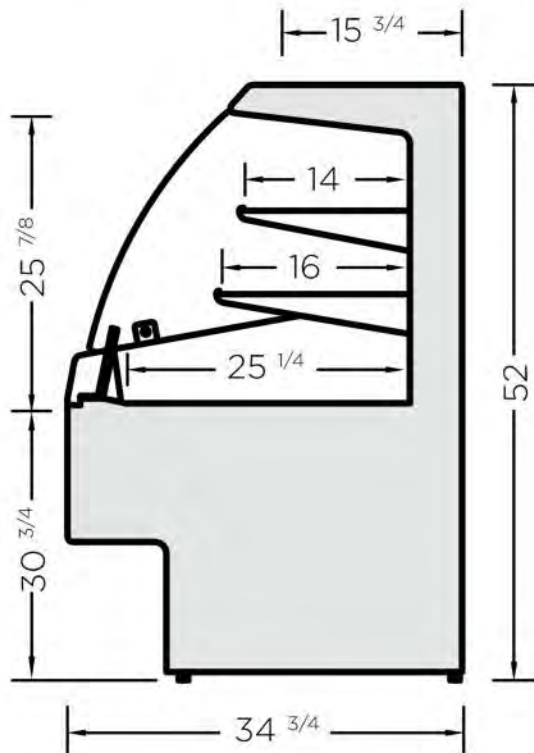



# SELF-SERVICE DISPLAY - 52" H

 REFRIGERATED

ELECTRICAL SPECS					
MODEL	LENGTH	VOLTS	AMPS	NEMA	
RSS-38-52	40 ¼"	115	12.3	5-20P	
RSS-48-52	49 ⅞"	115/230	8.7	L14-20P	
RSS-57-52	59 ⅜"	115/230	8.9	L14-20P	
RSS-76-52	78 ½"	115/230	10.5	L14-20P	
RSS-96-52	97 ⅝"	115/230	10.8	L14-20P	

INTERIOR FINISH	
Brushed Stainless Steel base inlay with textured black shelf standards and shelf supports	
Textured Black	
Textured White	

EXTERIOR FINISHES	
Category "A" laminate finish: <b>A-</b> _____	
Category "B" laminate finish: <b>B-</b> _____	
Other custom laminate specs:	
Brushed Stainless Steel	
Oak Veneer Plywood	
- Vertical grain direction	
- Horizontal grain direction	
Birch/Maple Veneer Plywood	
- Vertical grain direction	
- Horizontal grain direction	
Clear Finish applied to veneer	
Stain Finish Choice _____	
1" black McCue impact bumper strip applied to the front of the display	
Other McCue impact bumper strip colors Available upon request	

END PANELS	
Solid	
- LH (visualized from the front)	
- RH (visualized from the front)	
Contoured Tempered Glass	
- LH (visualized from the front)	
- RH (visualized from the front)	
Interior laminate the same as exterior	
Black interior	
White interior	
Brushed Stainless Steel interior	
Mirrored interior	
Mirrored end panel glass	
- Black T-mold edging	
- White T-mold edging	
- Stainless Steel T-mold edging	
1" black McCue impact bumper strip applied to the outside of the end panel	
Other McCue impact bumper strip colors available upon request	

MISCELLANEOUS	
Roll-down thermal night curtain	
Heavy duty lockable casters	
Add 1 shelf level (with integrated LED light strip)	
Eliminate 1 shelf level	
Rear venting kit for wall installation	

## ADDITIONAL FEATURES:

- Designed to maintain product temperature of 38-41°F with a maximum ambient atmosphere of 75°F/55% Humidity
- Hot gas condensate evaporation system
- ETL Listed and Sanitation certified to NSF 7
- 2 Year Parts & Labour Warranty
- Front air intake, rear discharge. Avoid any obstructions in these areas. A rear venting kit (for narrower width units) is available to install the display against a wall or where the back is obstructed

# SINGLE-LEVEL SELF-SERVICE DISPLAY - 42" H

 REFRIGERATED

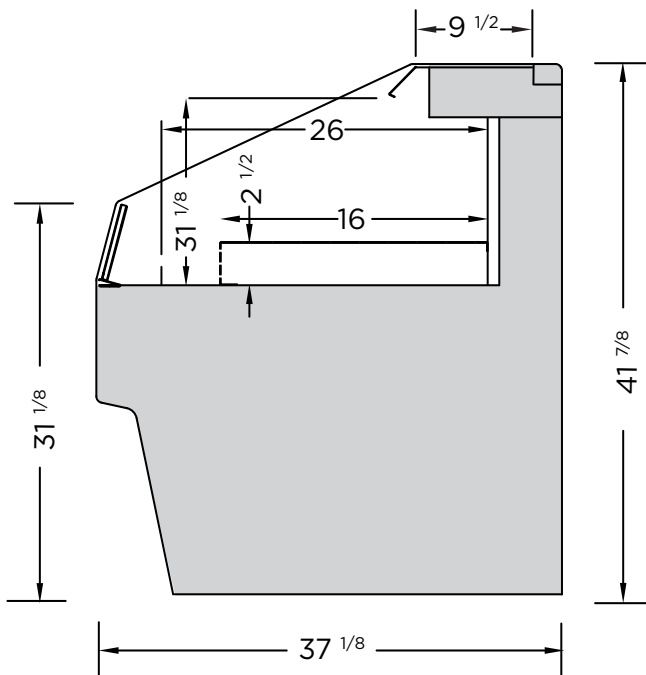







MODEL	LENGTH
MRO-38-42	40 1/4"
MRO-48-42	49 7/8"
MRO-57-42	59 3/8"
MRO-76-42	78 1/2"
MRO-96-42	97 5/8"

## FEATURES:

- 3 interior finishes available
- Many exterior colors, patterns and wood grain finishes available
- R-134A self-contained refrigeration
- Stepped riser inserts
- Removable base deck panels for easy cleaning and service
- Many options available. Refer to the options schedule on next page
- Rear venting included

## SUGGESTED APPLICATIONS:

-  Bakery
-  Restaurants
-  Deli
-  Butcher shops
-  Cafe
-  Produce

Note: Information and specifications may change due to engineering improvements.



# SINGLE-LEVEL SELF-SERVICE DISPLAY - 42" H

 REFRIGERATED

ELECTRICAL SPECS					
MODEL	LENGTH	VOLTS	AMPS	NEMA	
MRO-38-42	40 ¼"	115	11.8	5-15P	
MRO-48-42	49 ⅞"	115	12	5-15P	
MRO-57-42	59 ⅜"	115/230	8.9	L14-20P	
MRO-76-42	78 ½"	115/230	9.8	L14-20P	
MRO-96-42	97 ⅝"	115/230	10.3	L14-20P	

INTERIOR FINISH	
Brushed Stainless Steel base inlay with textured black shelf standards and shelf supports	
Textured Black	
Textured White	

EXTERIOR FINISHES	
Category "A" laminate finish: <b>A-</b> ____	
Category "B" laminate finish: <b>B-</b> ____	
Other custom laminate specs:	
Brushed Stainless Steel	
Oak Veneer Plywood	
- Vertical grain direction	
- Horizontal grain direction	
Birch/Maple Veneer Plywood	
- Vertical grain direction	
- Horizontal grain direction	
Clear Finish applied to veneer	
Stain Finish Choice _____	
1" black McCue impact bumper strip applied to the front of the display	
Other McCue impact bumper strip colors Available upon request	

END PANELS	
Interior laminate the same as exterior	
Black interior	
White interior	
Brushed Stainless Steel interior	
Mirrored interior	
Mirrored end panel glass	
- Black T-mold edging	
- White T-mold edging	
- Stainless Steel T-mold edging	
1" black McCue impact bumper strip applied to the outside of the end panel	
Other McCue impact bumper strip colors available upon request	

MISCELLANEOUS	
Roll-down thermal night curtain	
Heavy duty lockable casters	
Bolt-on top mounted dry shelving display	

## ADDITIONAL FEATURES:

- Designed to maintain product temperature of 38-41°F with a maximum ambient atmosphere of 75°F/55% Humidity
- Hot gas condensate evaporation system (most units)
- ETL Listed and Sanitation certified to NSF 7
- 2 Year Parts & Labour Warranty
- Front air intake, rear discharge. Avoid any obstructions in these areas.

# TWO-LEVEL SELF-SERVICE DISPLAY - 49" H

 REFRIGERATED

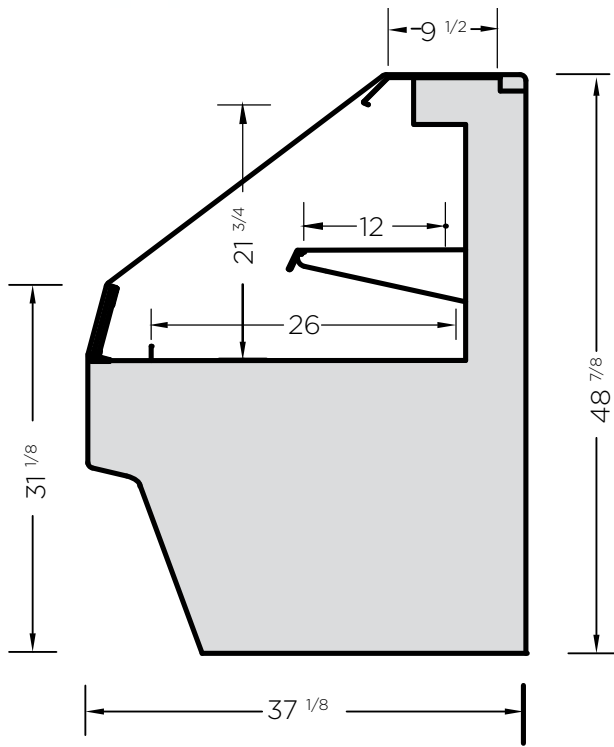







MODEL	LENGTH
MRO-38-49	40 1/4"
MRO-48-49	49 7/8"
MRO-57-49	59 3/8"
MRO-76-49	78 1/2"
MRO-96-49	97 5/8"

## FEATURES:

- 3 interior finishes available
- Many exterior colors, patterns and wood grain finishes available
- R-134A self-contained refrigeration
- 1 adjustable metal shelf with integrated LED lighting and raised front lip to attach price tag mould
- Removable base deck panels for easy cleaning and service
- Many options available. Refer to the options schedule on next page
- Rear venting included

## SUGGESTED APPLICATIONS:

- |   |   |
|---|---|
|  Bakery |  Restaurants   |
|  Deli   |  Butcher shops |
|  Cafe   |  Produce       |

Note: Information and specifications may change due to engineering improvements.



# TWO-LEVEL SELF-SERVICE DISPLAY - 49" H

 REFRIGERATED

ELECTRICAL SPECS					
MODEL	LENGTH	VOLTS	AMPS	NEMA	
MRO-38-49	40 ¼"	115	11.8	5-15P	
MRO-48-49	49 ⅞"	115	12	5-15P	
MRO-57-49	59 ⅜"	115/230	8.9	L14-20P	
MRO-76-49	78 ½"	115/230	9.8	L14-20P	
MRO-96-49	97 ⅝"	115/230	10.3	L14-20P	

INTERIOR FINISH	
Brushed Stainless Steel base inlay with textured black shelf standards and shelf supports	
Textured Black	
Textured White	

EXTERIOR FINISHES	
Category "A" laminate finish: <b>A-</b> _____	
Category "B" laminate finish: <b>B-</b> _____	
Other custom laminate specs:	
Brushed Stainless Steel	
Oak Veneer Plywood	
- Vertical grain direction	
- Horizontal grain direction	
Birch/Maple Veneer Plywood	
- Vertical grain direction	
- Horizontal grain direction	
Clear Finish applied to veneer	
Stain Finish Choice _____	
1" black McCue impact bumper strip applied to the front of the display	
Other McCue impact bumper strip colors Available upon request	

END PANELS	
Solid	
- LH (visualized from the front)	
- RH (visualized from the front)	
Contoured Tempered Glass	
- LH (visualized from the front)	
- RH (visualized from the front)	
Interior laminate the same as exterior	
Black interior	
White interior	
Brushed Stainless Steel interior	
Mirrored interior	
Mirrored end panel glass	
- Black T-mold edging	
- White T-mold edging	
- Stainless Steel T-mold edging	
1" black McCue impact bumper strip applied to the outside of the end panel	
Other McCue impact bumper strip colors available upon request	

MISCELLANEOUS	
Roll-down thermal night curtain	
Heavy duty lockable casters	
Bolt-on top mounted dry shelving display	
Step riser insert	

## ADDITIONAL FEATURES:

- Designed to maintain product temperature of 38-41°F with a maximum ambient atmosphere of 75°F/55% Humidity
- Hot gas condensate evaporation system (most units)
- ETL Listed and Sanitation certified to NSF 7
- 2 Year Parts & Labour Warranty
- Front air intake, rear discharge. Avoid any obstructions in these areas.



# SELF-SERVICE DISPLAY - 54" H

 REFRIGERATED

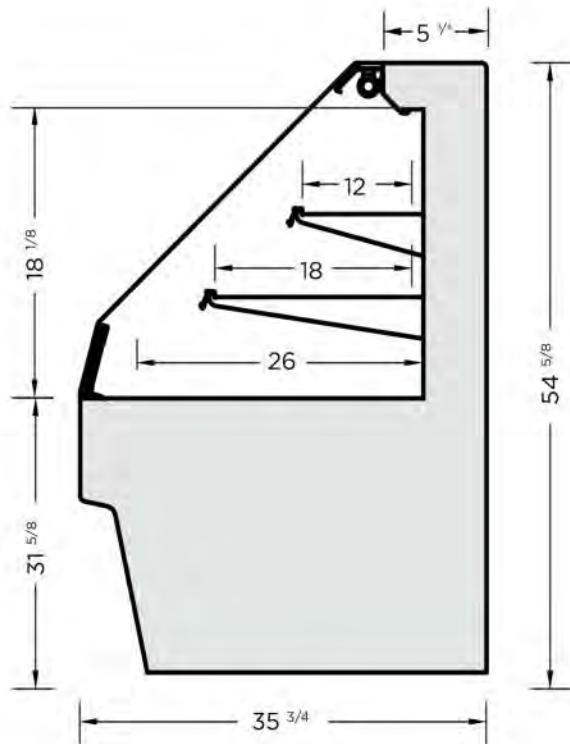







MODEL	LENGTH
MRO-38-54	40 1/4"
MRO-48-54	49 7/8"
MRO-57-54	59 3/8"
MRO-76-54	78 1/2"
MRO-96-54	97 5/8"

## FEATURES:

- 3 interior finishes available
- Many exterior colors, patterns and wood grain finishes available
- R-134A self-contained refrigeration
- 2 adjustable metal shelves with integrated LED lighting and raised front lip to attach price tag mould
- Removable base deck panels for easy cleaning and service
- Many options available. Refer to the options schedule on next page
- Rear venting included

## SUGGESTED APPLICATIONS:

- |   |   |
|---|---|
|  Bakery |  Restaurants   |
|  Deli   |  Butcher shops |
|  Cafe   |  Produce       |

Note: Information and specifications may change due to engineering improvements.



# SELF-SERVICE DISPLAY - 54" H

REFRIGERATED

ELECTRICAL SPECS					
MODEL	LENGTH	VOLTS	AMPS	NEMA	
MRO-38-54	40 ¼"	115	11.8	5-15P	
MRO-48-54	49 ⅞"	115/230	8.7	L14-20P	
MRO-57-54	59 ⅜"	115/230	8.9	L14-20P	
MRO-76-54	78 ½"	115/230	9.8	L14-20P	
MRO-96-54	97 ⅝"	115/230	10.3	L14-20P	

INTERIOR FINISH	
Brushed Stainless Steel base inlay with textured black shelf standards and shelf supports	
Textured Black	
Textured White	

EXTERIOR FINISHES	
Category "A" laminate finish: <b>A-</b> _____	
Category "B" laminate finish: <b>B-</b> _____	
Other custom laminate specs:	
Brushed Stainless Steel	
Oak Veneer Plywood	
- Vertical grain direction	
- Horizontal grain direction	
Birch/Maple Veneer Plywood	
- Vertical grain direction	
- Horizontal grain direction	
Clear Finish applied to veneer	
Stain Finish Choice _____	
1" black McCue impact bumper strip applied to the front of the display	
Other McCue impact bumper strip colors Available upon request	

END PANELS	
Solid	
- LH (visualized from the front)	
- RH (visualized from the front)	
Contoured Tempered Glass	
- LH (visualized from the front)	
- RH (visualized from the front)	
Interior laminate the same as exterior	
Black interior	
White interior	
Brushed Stainless Steel interior	
Mirrored interior	
Mirrored end panel glass	
- Black T-mold edging	
- White T-mold edging	
- Stainless Steel T-mold edging	
1" black McCue impact bumper strip applied to the outside of the end panel	
Other McCue impact bumper strip colors available upon request	

MISCELLANEOUS	
Roll-down thermal night curtain	
Heavy duty lockable casters	
Add 1 shelf level (with integrated LED light strip)	
Eliminate 1 shelf level	
Rear venting kit for wall installation	

## ADDITIONAL FEATURES:

- Designed to maintain product temperature of 38-41°F with a maximum ambient atmosphere of 75°F/55% Humidity
- Hot gas condensate evaporation system (most units)
- ETL Listed and Sanitation certified to NSF 7
- 2 Year Parts & Labour Warranty
- Front air intake, rear discharge. Avoid any obstructions in these areas.

# SELF-SERVICE DISPLAY - 54" H

 REFRIGERATED

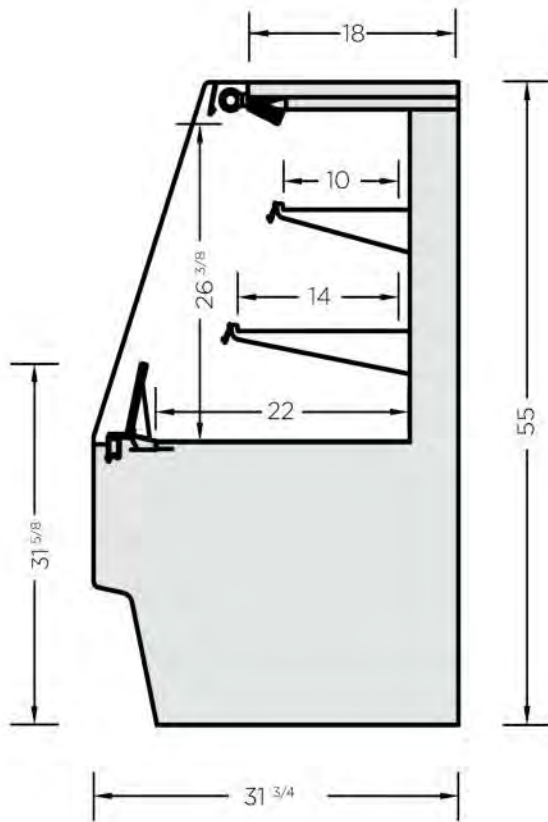







MODEL	LENGTH
GP3-38-54	40 1/4"
GP3-48-54	49 7/8"
GP3-57-54	59 3/8"

## FEATURES:

- 3 interior finishes available
- Many exterior colors, patterns and wood grain finishes available
- R-134A self-contained refrigeration
- 2 adjustable metal shelves with integrated LED lighting and raised front lip to attach price tag mould
- Removable base deck panels for easy cleaning and service
- LED lighting attached to the top ledge of the display
- Many options available. Refer to the options schedule on next page

## SUGGESTED APPLICATIONS:

- |   |   |
|---|---|
|  Bakery |  Restaurants   |
|  Deli   |  Butcher shops |
|  Cafe   |  Produce       |

Note: Information and specifications may change due to engineering improvements.



# SELF-SERVICE DISPLAY - 54" H

 REFRIGERATED

ELECTRICAL SPECS					
MODEL	LENGTH	VOLTS	AMPS	NEMA	
GP3-38-54	40 ¼"	115	12.3	5-20P	
GP3-48-54	49 ⅞"	115/230	8.7	L14-20P	
GP3-57-54	59 ⅜"	115/230	8.9	L14-20P	

INTERIOR FINISH	
Brushed Stainless Steel base inlay with textured black shelf standards and shelf supports	
Textured Black	
Textured White	

EXTERIOR FINISHES	
Category "A" laminate finish: <b>A-</b> ____	
Category "B" laminate finish: <b>B-</b> ____	
Other custom laminate specs:	
Brushed Stainless Steel	
Oak Veneer Plywood	
- Vertical grain direction	
- Horizontal grain direction	
Birch/Maple Veneer Plywood	
- Vertical grain direction	
- Horizontal grain direction	
Clear Finish applied to veneer	
Stain Finish Choice _____	
1" black McCue impact bumper strip applied to the front of the display	
Other McCue impact bumper strip colors Available upon request	

END PANELS	
Solid	
- LH (visualized from the front)	
- RH (visualized from the front)	
Contoured Tempered Glass	
- LH (visualized from the front)	
- RH (visualized from the front)	
Interior laminate the same as exterior	
Black interior	
White interior	
Brushed Stainless Steel interior	
Mirrored interior	
Mirrored end panel glass	
- Black T-mold edging	
- White T-mold edging	
- Stainless Steel T-mold edging	
1" black McCue impact bumper strip applied to the outside of the end panel	
Other McCue impact bumper strip colors available upon request	

MISCELLANEOUS	
Roll-down thermal night curtain	
Heavy duty lockable casters	
Add 1 shelf level (with integrated LED light strip)	
Eliminate 1 shelf level	
Rear venting kit for wall installation	

## ADDITIONAL FEATURES:

- Designed to maintain product temperature of 38-41°F with a maximum ambient atmosphere of 75°F/55% Humidity
- Hot gas condensate evaporation system
- ETL Listed and Sanitation certified to NSF 7
- 2 Year Parts & Labour Warranty
- Front air intake, rear discharge. Avoid any obstructions in these areas.

# SELF-SERVICE DISPLAY - 60" H

 REFRIGERATED

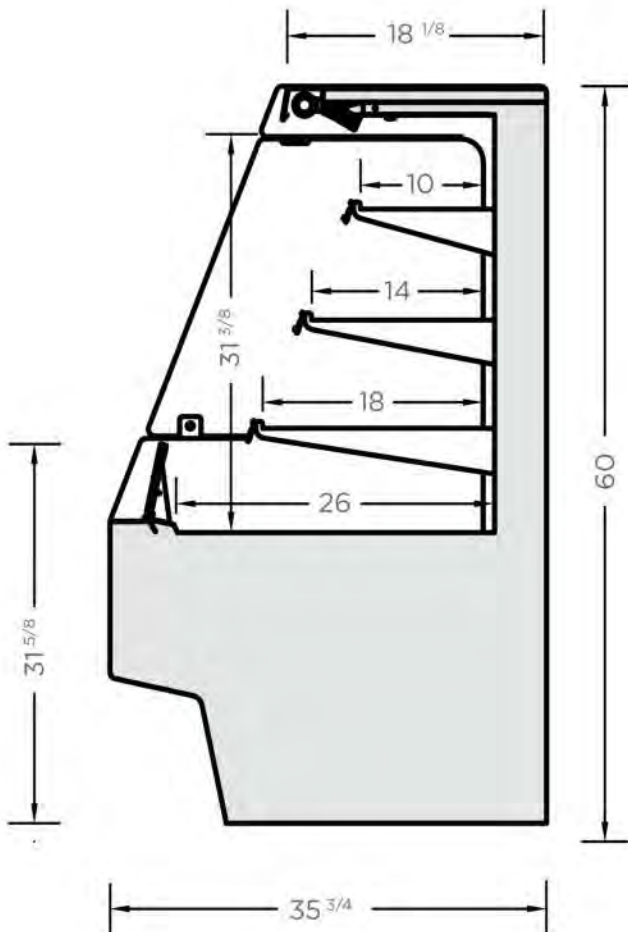

MODEL	LENGTH
GP4-38-60	40 1/4"
GP4-48-60	49 7/8"
GP4-57-60	59 3/8"

## FEATURES:

- 3 interior finishes available
- Many exterior colors, patterns and wood grain finishes available
- R-134A self-contained refrigeration
- 3 adjustable metal shelves with integrated LED lighting and raised front lip to attach price tag mould
- Removable base deck panels for easy cleaning and service
- LED lighting attached to the top ledge of the display
- Many options available. Refer to the options schedule on next page

## SUGGESTED APPLICATIONS:

- |   |   |
|---|---|
|  Bakery |  Restaurants   |
|  Deli   |  Butcher shops |
|  Cafe   |  Produce       |

www. Information and specifications may change due to engineering improvements



# SELF-SERVICE DISPLAY - 60" H

 REFRIGERATED

## ELECTRICAL SPECS

MODEL	LENGTH	VOLTS	AMPS	NEMA	
GP4-38-60	40 ¼"	115	12.3	5-20P	
GP4-48-60	49 ⅞"	115/230	8.7	L14-20P	
GP4-57-60	59 ⅜"	115/230	8.9	L14-20P	

## INTERIOR FINISH

Brushed Stainless Steel base inlay with textured black shelf standards and shelf supports	
Textured Black	
Textured White	

## EXTERIOR FINISHES

Category "A" laminate finish: <b>A-</b> _____	
Category "B" laminate finish: <b>B-</b> _____	
Other custom laminate specs:	
Brushed Stainless Steel	
Oak Veneer Plywood	
- Vertical grain direction	
- Horizontal grain direction	
Birch/Maple Veneer Plywood	
- Vertical grain direction	
- Horizontal grain direction	
Clear Finish applied to veneer	
Stain Finish Choice _____	
1" black McCue impact bumper strip applied to the front of the display	
Other McCue impact bumper strip colors Available upon request	

## END PANELS

Solid	
- LH (visualized from the front)	
- RH (visualized from the front)	
Contoured Tempered Glass	
- LH (visualized from the front)	
- RH (visualized from the front)	
Interior laminate the same as exterior	
Black interior	
White interior	
Brushed Stainless Steel interior	
Mirrored interior	
Mirrored end panel glass	
- Black T-mold edging	
- White T-mold edging	
- Stainless Steel T-mold edging	
1" black McCue impact bumper strip applied to the outside of the end panel	
Other McCue impact bumper strip colors available upon request	

## MISCELLANEOUS

Roll-down thermal night curtain	
Heavy duty lockable casters	
Add 1 shelf level (with integrated LED light strip)	
Eliminate 1 shelf level	
Rear venting kit for wall installation	

## ADDITIONAL FEATURES:

- Designed to maintain product temperature of 38-41°F with a maximum ambient atmosphere of 75°F/55% Humidity
- Hot gas condensate evaporation system
- ETL Listed and Sanitation certified to NSF 7
- 2 Year Parts & Labour Warranty
- Front air intake, rear discharge. Avoid any obstructions in these areas.

# SLIM-LINE SELF-SERVICE DISPLAY - 60" H

 REFRIGERATED

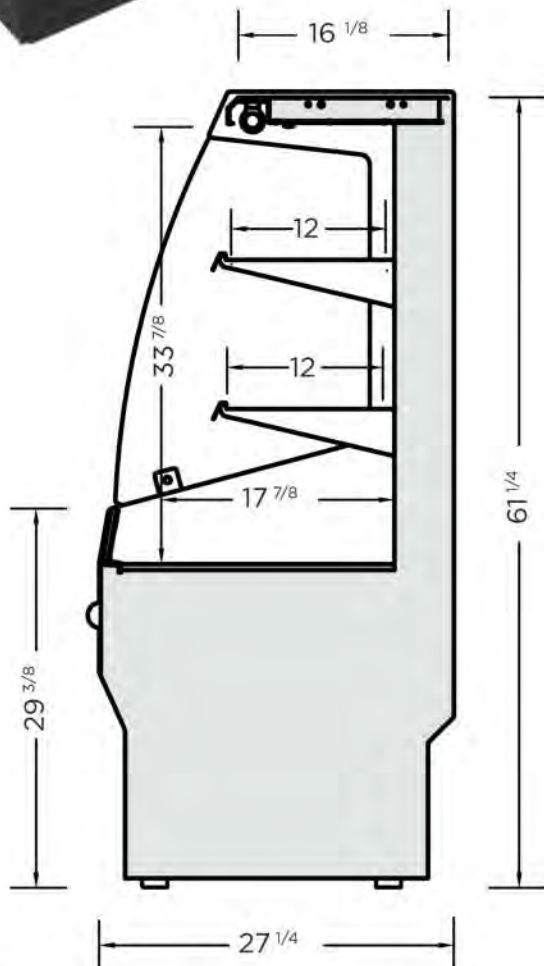







MODEL	LENGTH
RSL-38-60	40 1/4"
RSL-48-60	49 7/8"
RSL-57-60	59 3/8"

## FEATURES:

- 3 interior finishes available
- Many exterior colors, patterns and wood grain finishes available
- R-134A self-contained refrigeration
- 2 adjustable metal shelves with integrated LED lighting and raised front lip to attach price tag mould
- Removable base deck panels for easy cleaning and service
- LED lighting attached to the top ledge of the display
- Many options available. Refer to the options schedule on next page

## SUGGESTED APPLICATIONS:

- |   |   |
|---|---|
|  Bakery |  Restaurants   |
|  Deli   |  Butcher shops |
|  Cafe   |  Produce       |

Note: Information and specifications may change due to engineering improvements.



# SLIM-LINE SELF-SERVICE DISPLAY - 60" H

 REFRIGERATED

ELECTRICAL SPECS					
MODEL	LENGTH	VOLTS	AMPS	NEMA	
RSL-38-60	40 ¼"	115	12.3	5-20P	
RSL-48-60	49 ⅞"	115/230	8.7	L14-20P	
RSL-57-60	59 ⅜"	115/230	8.9	L14-20P	

INTERIOR FINISH	
Brushed Stainless Steel base inlay with textured black shelf standards and shelf supports	
Textured Black	
Textured White	

EXTERIOR FINISHES	
Category "A" laminate finish: <b>A-</b> ____	
Category "B" laminate finish: <b>B-</b> ____	
Other custom laminate specs:	
Brushed Stainless Steel	
Oak Veneer Plywood	
- Vertical grain direction	
- Horizontal grain direction	
Birch/Maple Veneer Plywood	
- Vertical grain direction	
- Horizontal grain direction	
Clear Finish applied to veneer	
Stain Finish Choice _____	
1" black McCue impact bumper strip applied to the front of the display	
Other McCue impact bumper strip colors Available upon request	

END PANELS	
Solid	
- LH (visualized from the front)	
- RH (visualized from the front)	
Contoured Tempered Glass	
- LH (visualized from the front)	
- RH (visualized from the front)	
Interior laminate the same as exterior	
Black interior	
White interior	
Brushed Stainless Steel interior	
Mirrored interior	
Mirrored end panel glass	
- Black T-mold edging	
- White T-mold edging	
- Stainless Steel T-mold edging	
1" black McCue impact bumper strip applied to the outside of the end panel	
Other McCue impact bumper strip colors available upon request	

MISCELLANEOUS	
Roll-down thermal night curtain	
Heavy duty lockable casters	
Add 1 shelf level (with integrated LED light strip)	
Eliminate 1 shelf level	
Rear venting kit for wall installation	

## ADDITIONAL FEATURES:

- Designed to maintain product temperature of 38-41°F with a maximum ambient atmosphere of 75°F/55% Humidity
- Hot gas condensate evaporation system
- ETL Listed and Sanitation certified to NSF 7
- 2 Year Parts & Labour Warranty
- Front air intake, rear discharge. Avoid any obstructions in these areas.



# UPRIGHT SELF-SERVICE DISPLAY - 76" H

 REFRIGERATED

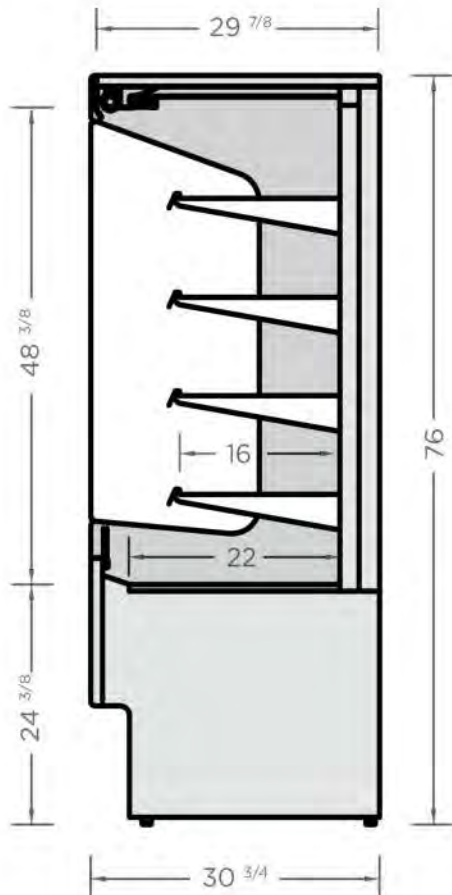







MODEL	LENGTH
RSS-38-76	40 1/4"
RSS-48-76	49 7/8"
RSS-57-76	59 3/8"

## FEATURES:

- 3 interior finishes available
- Many exterior colors, patterns and wood grain finishes available
- R-134A self-contained refrigeration
- 4 adjustable metal shelves with integrated LED lighting and raised front lip to attach price tag mould
- Removable base deck panels for easy cleaning and service
- LED lighting attached to the top ledge of the display
- Many options available. Refer to the options schedule on next page

## SUGGESTED APPLICATIONS:

- |   |   |
|---|---|
|  Bakery |  Restaurants   |
|  Deli   |  Butcher shops |
|  Cafe   |  Produce       |

Note: Information and specifications may change due to engineering improvements.



## UPRIGHT SELF-SERVICE DISPLAY - 76" H

 REFRIGERATED

### ELECTRICAL SPECS

MODEL	LENGTH	VOLTS	AMPS	NEMA	
RSS-38-76	40 ¼"	115	12.3	5-20P	
RSS-48-76	49 ⅞"	115/230	8.7	L14-20P	
RSS-57-76	59 ⅜"	115/230	8.9	L14-20P	

### INTERIOR FINISH

Brushed Stainless Steel base inlay with textured black shelf standards and shelf supports	
Textured Black	
Textured White	

### EXTERIOR FINISHES

Category "A" laminate finish: <b>A-</b> ____	
Category "B" laminate finish: <b>B-</b> ____	
Other custom laminate specs:	
Brushed Stainless Steel	
Oak Veneer Plywood	
- Vertical grain direction	
- Horizontal grain direction	
Birch/Maple Veneer Plywood	
- Vertical grain direction	
- Horizontal grain direction	
Clear Finish applied to veneer	
Stain Finish Choice _____	
1" black McCue impact bumper strip applied to the front of the display	
Other McCue impact bumper strip colors Available upon request	

### ADDITIONAL FEATURES:

- Designed to maintain product temperature of 38-41°F with a maximum ambient atmosphere of 75°F/55% Humidity
- Hot gas condensate evaporation system
- ETL Listed and Sanitation certified to NSF 7
- 2 Year Parts & Labour Warranty
- Front air intake, rear discharge. Avoid any obstructions in these areas. A rear venting kit (for narrower width units) is available to install the display against a wall or where the back is obstructed

### END PANELS

Solid	
- LH (visualized from the front)	
- RH (visualized from the front)	
Contoured Tempered Glass	
- LH (visualized from the front)	
- RH (visualized from the front)	
Interior laminate the same as exterior	
Black interior	
White interior	
Brushed Stainless Steel interior	
Mirrored interior	
Mirrored end panel glass	
- Black T-mold edging	
- White T-mold edging	
- Stainless Steel T-mold edging	
1" black McCue impact bumper strip applied to the outside of the end panel	
Other McCue impact bumper strip colors available upon request	

### MISCELLANEOUS

Roll-down thermal night curtain	
Add 1 shelf level (with integrated lighting)	
Eliminate 1 shelf level	
Tempered glass shelves instead of the standard metal shelves	
Top vent trim kit	
Roll-down security panel	

# COMBINATION SERVICE/ SELF-SERVICE DISPLAY

REFRIGERATED

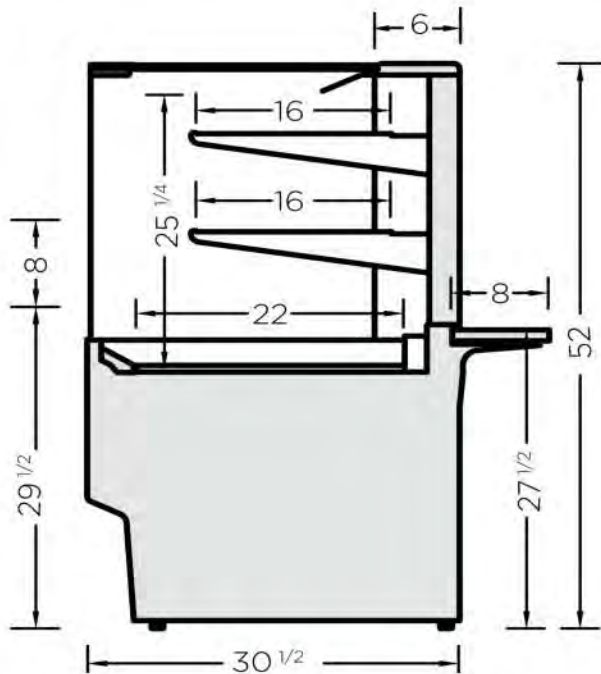

MODEL	LENGTH
SG-SSS-38	40 1/4"
SG-SSS-48	49 7/8"
SG-SSS-57	59 3/8"
SG-SSS-76	78 1/2"

## FEATURES:

- 3 interior finishes available
- Many exterior colors, patterns and wood grain finishes available
- R-134a self contained refrigeration
- 2 adjustable tempered glass shelves with integrated LED lighting
- Opening in the front glass to provide a self-service base display
- Removable base deck panels for easy cleaning and service
- LED lighting attached to the top ledge of the display
- Thermal rear sliding doors
- Many options available. Refer to the options schedule on next page

## SUGGESTED APPLICATIONS:

- Bakery
- Restaurants
- Deli
- Butcher shops
- Cafe

Note: Information and specifications may change due to engineering improvements



# COMBINATION SERVICE/ SELF-SERVICE DISPLAY

 REFRIGERATED

ELECTRICAL SPECS					
MODEL	LENGTH	VOLTS	AMPS	NEMA	
SG-SSS-38	40 ¼"	115	11.8	5-15P	
SG-SSS-48	49 ⅞"	115	12	5-15P	
SG-SSS-57	59 ⅜"	115/230	8.9	L14-20P	
SG-SSS-76	78 ½"	115/230	9.8	L14-20P	

INTERIOR FINISH	
Brushed Stainless Steel base inlay with textured black shelf standards and shelf supports	
Textured Black	
Textured White	

EXTERIOR FINISHES	
Category "A" laminate finish: <b>A-</b> ____	
Category "B" laminate finish: <b>B-</b> ____	
Other custom laminate specs:	
Brushed Stainless Steel	
Oak Veneer Plywood	
- Vertical grain direction	
- Horizontal grain direction	
Birch/Maple Veneer Plywood	
- Vertical grain direction	
- Horizontal grain direction	
Clear Finish applied to veneer	
Stain Finish Choice _____	
1" black McCue impact bumper strip applied to the front of the display	
Other McCue impact bumper strip colors Available upon request	

END PANELS	
Solid	
- LH (visualized from the front)	
- RH (visualized from the front)	
Contoured Tempered Glass	
- LH (visualized from the front)	
- RH (visualized from the front)	
Interior laminate the same as exterior	
Black interior	
White interior	
Brushed Stainless Steel interior	
Mirrored interior	
Mirrored end panel glass	
- Black T-mold edging	
- White T-mold edging	
- Stainless Steel T-mold edging	
1" black McCue impact bumper strip applied to the outside of the end panel	
Other McCue impact bumper strip colors available upon request	

MISCELLANEOUS	
Heavy duty lockable casters	
Rear fold-down work shelf	
Mirrored rear sliding doors	
Wire security grill panel for service display area	

## ADDITIONAL FEATURES:

- Designed to maintain product temperature of 38-41°F with a maximum ambient atmosphere of 75°F/55% humidity
- Hot gas condensate evaporation system
- ETL Listed and Sanitation certified to NSF 7
- 2 Year Parts & Labour Warranty
- Rear air intake, front discharge. Avoid any obstructions in these areas

# SERVICE DISPLAY

REFRIGERATED

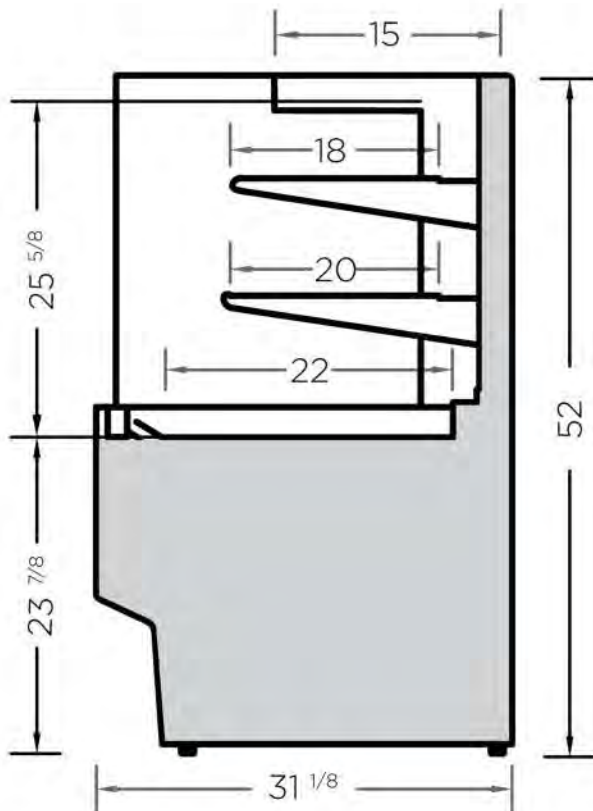





MODEL	LENGTH
SG-RH3-38	40 1/4"
SG-RH3-48	49 7/8"
SG-RH3-57	59 3/8"
SG-RH3-76	78 1/2"
SG-RH3-96	97 5/8"

## FEATURES:

- 3 interior finishes available
- Many exterior colors, patterns and wood grain finishes available
- R-134A self-contained refrigeration
- 2 adjustable tempered glass shelves with integrated LED lighting
- Removable base deck panels for easy cleaning and service
- Air circulating defogging system to keep the front glass clear of condensation
- LED lighting attached to the top ledge of the display
- Thermal rear sliding doors
- Exclusive ONE PIECE 90 degree bent front glass for better presentation and glass alignment.
- Tilt-out front glass for easy cleaning
- Many options available. Refer to the options schedule on next page

## SUGGESTED APPLICATIONS:

-  Bakery
-  Restaurants
-  Deli
-  Butcher shops
-  Cafe

Model information and specifications may change due to engineering improvements.



# SERVICE DISPLAY

 REFRIGERATED

ELECTRICAL SPECS					
MODEL	LENGTH	VOLTS	AMPS	NEMA	
SG-RH3-38	40 ¼"	115	9.1	5-15P	
SG-RH3-48	49 ⅞"	115	12.3	5-20P	
SG-RH3-57	59 ⅜"	115	13	5-20P	
SG-RH3-76	78 ½"	115/230	9.8	L14-20P	
SG-RH3-96	97 ⅝"	115/230	10.3	L14-20P	

INTERIOR FINISH	
Brushed Stainless Steel base inlay with textured black shelf standards and shelf supports	
Textured Black	
Textured White	

EXTERIOR FINISHES	
Category "A" laminate finish: <b>A-</b> _____	
Category "B" laminate finish: <b>B-</b> _____	
Other custom laminate specs:	
Brushed Stainless Steel	
Oak Veneer Plywood	
- Vertical grain direction	
- Horizontal grain direction	
Birch/Maple Veneer Plywood	
- Vertical grain direction	
- Horizontal grain direction	
Clear Finish applied to veneer	
Stain Finish Choice _____	
1" black McCue impact bumper strip applied to the front of the display	
Other McCue impact bumper strip colors Available upon request	

### ADDITIONAL FEATURES:

- Designed to maintain product temperature of 38-41°F with a maximum ambient atmosphere of 75°F/55% humidity
- Hot gas condensate evaporation system
- ETL Listed and Sanitation certified to NSF 7
- 2 Year Parts & Labour Warranty
- Rear air intake, front discharge. Avoid any obstructions in these areas

END PANELS	
Solid	
- LH (visualized from the front)	
- RH (visualized from the front)	
Contoured Tempered Glass	
- LH (visualized from the front)	
- RH (visualized from the front)	
Interior laminate the same as exterior	
Black interior	
White interior	
Brushed Stainless Steel interior	
Mirrored interior	
Mirrored end panel glass	
- Black T-mold edging	
- White T-mold edging	
- Stainless Steel T-mold edging	
1" black McCue impact bumper strip applied to the outside of the end panel	
Other McCue impact bumper strip colors available upon request	

MISCELLANEOUS	
Heavy duty lockable casters	
Rear fold-down work shelf	
Add 1 shelf level (with LED light strip)	
Eliminate 1 shelf level	
Mirrored rear sliding doors	
Locks for rear sliding doors	

# DRY SERVICE DISPLAY

□ AMBIENT

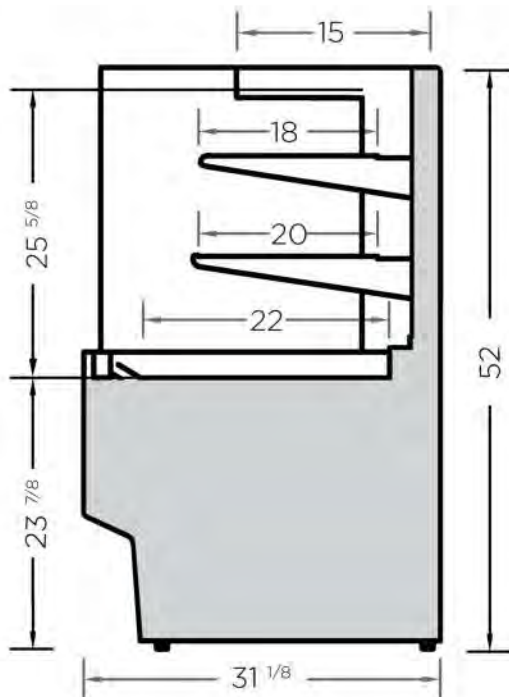

MODEL	LENGTH
SG-DH3-38	40 1/4"
SG-DH3-48	49 7/8"
SG-DH3-57	59 3/8"

## FEATURES:

- 3 interior finishes available
- Many exterior colors, patterns and wood grain finishes available
- 2 adjustable tempered glass shelves with integrated LED lighting
- Removable base deck panels for easy cleaning and service
- Tilt-out front glass for easy cleaning
- LED lighting attached to the top ledge of the display
- Thermal rear sliding doors
- Exclusive ONE PIECE 90 degree bent front glass for better presentation and alignment.
- Many options available. Refer to the options schedule on next page

## SUGGESTED APPLICATIONS:

- Bakery
- Restaurants
- Deli
- Butcher shops
- Cafe

Note: Information and specifications may change due to engineering improvements.



# DRY SERVICE DISPLAY

□ AMBIENT

## ELECTRICAL SPECS

MODEL	LENGTH	VOLTS	AMPS	NEMA	
SG-DH3-38	40 ¼"	115	.5	5-15P	
SG-DH3-48	49 ⅞"	115	.5	5-15P	
SG-DH3-57	59 ⅜"	115	1.0	5-15P	

## INTERIOR FINISH

Brushed Stainless Steel base inlay with textured black shelf standards and shelf supports	
Textured Black	
Textured White	

## EXTERIOR FINISHES

Category "A" laminate finish: <b>A-</b> ____	
Category "B" laminate finish: <b>B-</b> ____	
Other custom laminate specs:	
Brushed Stainless Steel	
Oak Veneer Plywood	
- Vertical grain direction	
- Horizontal grain direction	
Birch/Maple Veneer Plywood	
- Vertical grain direction	
- Horizontal grain direction	
Clear Finish applied to veneer	
Stain Finish Choice _____	
1" black McCue impact bumper strip applied to the front of the display	
Other McCue impact bumper strip colors Available upon request	

## ADDITIONAL FEATURES:

- ETL Listed and Sanitation certified to NSF 7
- 2 Year Parts & Labour Warranty

## END PANELS

Solid	
- LH (visualized from the front)	
- RH (visualized from the front)	
Contoured Tempered Glass	
- LH (visualized from the front)	
- RH (visualized from the front)	
Interior laminate the same as exterior	
Black interior	
White interior	
Brushed Stainless Steel interior	
Mirrored interior	
Mirrored end panel glass	
- Black T-mold edging	
- White T-mold edging	
- Stainless Steel T-mold edging	
1" black McCue impact bumper strip applied to the outside of the end panel	
Other McCue impact bumper strip colors available upon request	

## MISCELLANEOUS

Heavy duty lockable casters	
Rear fold-down work shelf	
Add 1 shelf level (with integrated LED light strip)	
Eliminate 1 shelf level	
Mirrored rear sliding doors	
Locks for rear sliding doors	



# SELF-SERVICE DISPLAY - 52" H

 REFRIGERATED

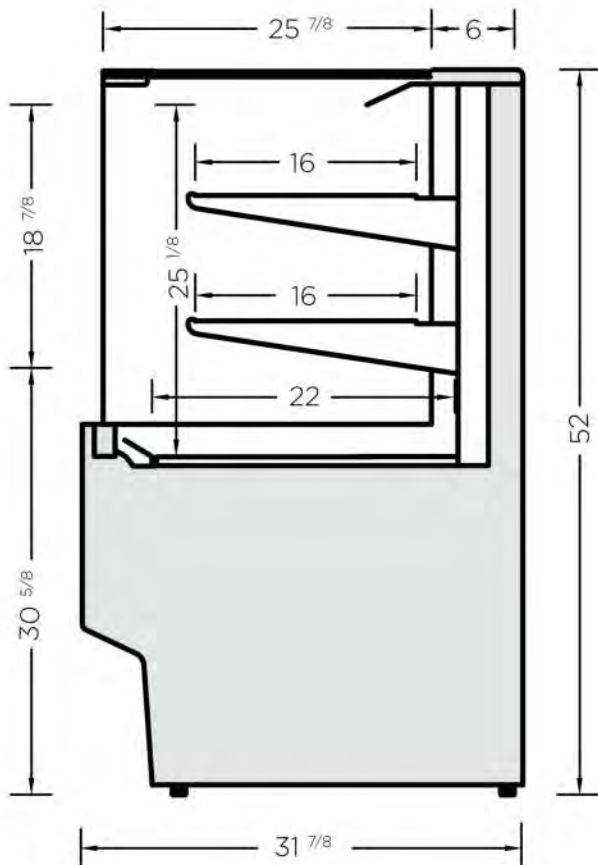



MODEL	LENGTH
SG-RSS-38-52	40 1/4"
SG-RSS-48-52	49 7/8"
SG-RSS-57-52	59 3/8"
SG-RSS-76-52	78 1/2"
SG-RSS-96-52	97 5/8"

## FEATURES:

- 3 interior finishes available
- Many exterior colors, patterns and wood grain finishes available
- R-134A self-contained refrigeration
- 2 adjustable tempered glass shelves with integrated LED lighting
- Removable base deck panels for easy cleaning and service
- LED lighting attached to the top ledge of the display
- Many options available. Refer to the options schedule on next page

## SUGGESTED APPLICATIONS:

-  Bakery
-  Restaurants
-  Deli
-  Butcher shops
-  Cafe
-  Produce

Note: Information and specifications may change due to engineering improvements.



## SELF-SERVICE DISPLAY - 52" H

REFRIGERATED

### ELECTRICAL SPECS

MODEL	LENGTH	VOLTS	AMPS	NEMA
SG-RSS-38-52	40 ¼"	115	12.3	5-20P
SG-RSS-48-52	49 ⅞"	115/230	8.7	L14-20P
SG-RSS-57-52	59 ⅜"	115/230	8.9	L14-20P
SG-RSS-76-52	78 ½"	115/230	10.5	L14-20P
SG-RSS-96-52	97 ⅝"	115/230	10.8	L14-20P

### INTERIOR FINISH

Brushed Stainless Steel base inlay with textured black shelf standards and shelf supports	
Textured Black	
Textured White	

### EXTERIOR FINISHES

Category "A" laminate finish: <b>A-</b> _____	
Category "B" laminate finish: <b>B-</b> _____	
Other custom laminate specs:	
Brushed Stainless Steel	
Oak Veneer Plywood	
- Vertical grain direction	
- Horizontal grain direction	
Birch/Maple Veneer Plywood	
- Vertical grain direction	
- Horizontal grain direction	
Clear Finish applied to veneer	
Stain Finish Choice _____	
1" black McCue impact bumper strip applied to the front of the display	
Other McCue impact bumper strip colors Available upon request	

### END PANELS

Solid	
- LH (visualized from the front)	
- RH (visualized from the front)	
Contoured Tempered Glass	
- LH (visualized from the front)	
- RH (visualized from the front)	
Interior laminate the same as exterior	
Black interior	
White interior	
Brushed Stainless Steel interior	
Mirrored interior	
Mirrored end panel glass	
- Black T-mold edging	
- White T-mold edging	
- Stainless Steel T-mold edging	
1" black McCue impact bumper strip applied to the outside of the end panel	
Other McCue impact bumper strip colors available upon request	

### MISCELLANEOUS

Roll-down thermal night curtain	
Heavy duty lockable casters	
Add 1 shelf level (with integrated LED light strip)	
Eliminate 1 shelf level	
Rear venting kit for wall installation	

### ADDITIONAL FEATURES:

- Designed to maintain product temperature of 38-41°F with a maximum ambient atmosphere of 75°F/55% Humidity
- Hot gas condensate evaporation system
- ETL Listed and Sanitation certified to NSF 7
- 2 Year Parts & Labour Warranty
- Rear air intake, front discharge. Avoid any obstructions in these areas. A rear venting kit (for narrower width units) is available to install the display against a wall or where the back is obstructed

# COMBINATION DRY/REFRIGERATED SELF-SERVICE DISPLAY

 REFRIGERATED

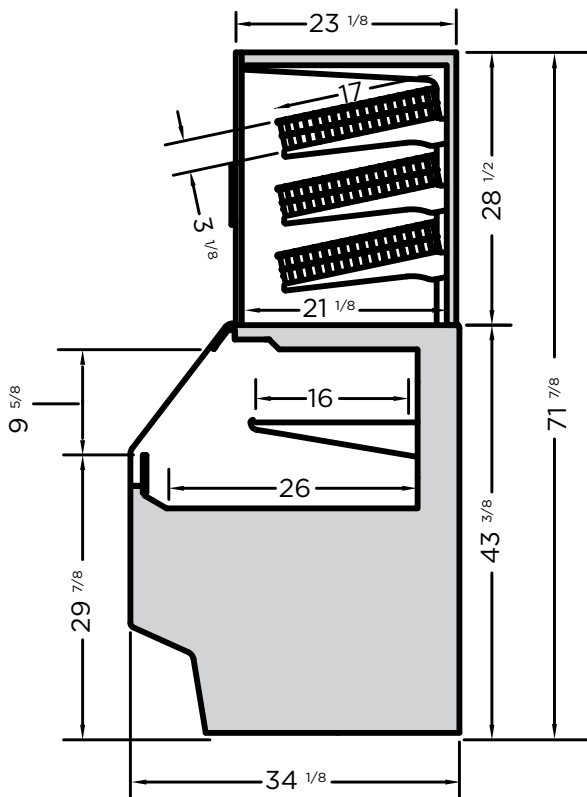

MODEL	LENGTH
SSC-38-72	40 1/4"
SSC-48-72	49 7/8"
SSC-57-72	59 3/8"

## FEATURES:

- 3 interior finishes available
- Many exterior colors, patterns and wood grain finishes available
- R-134A self-contained refrigeration (lower section)
- 3 upper adjustable shelves with integrated PTM & LED lighting
- 1 lower adjustable tempered metal shelf with integrated PTM & LED lighting
- Removable base deck panels for easy cleaning and service
- LED lighting attached to the top ledge of the display
- Many options available. Refer to the options schedule on next page

## SUGGESTED APPLICATIONS:

-  Bakery
-  Cafe

Note: Information and specifications may change due to engineering improvements.



# COMBINATION DRY/REFRIGERATED SELF-SERVICE DISPLAY

 REFRIGERATED

## ELECTRICAL SPECS

MODEL	LENGTH	VOLTS	AMPS	NEMA	
SSC-38-72	40 ¼"	115	11.0	5-15P	
SSC-48-72	49 ⅞"	115	11.2	5-15P	
SSC-57-72	59 ⅜"	115/230	8.5	L14-20P	

## INTERIOR FINISH

Brushed Stainless Steel base inlay with textured black shelf standards and shelf supports	
Textured Black	
Textured White	

## EXTERIOR FINISHES

Category "A" laminate finish: <b>A-</b> ____	
Category "B" laminate finish: <b>B-</b> ____	
Other custom laminate specs:	
Brushed Stainless Steel	
Oak Veneer Plywood	
- Vertical grain direction	
- Horizontal grain direction	
Birch/Maple Veneer Plywood	
- Vertical grain direction	
- Horizontal grain direction	
Clear Finish applied to veneer	
Stain Finish Choice _____	
1" black McCue impact bumper strip applied to the front of the display	
Other McCue impact bumper strip colors Available upon request	

## END PANELS

Solid	
- LH (visualized from the front)	
- RH (visualized from the front)	
Interior laminate the same as exterior	
Black interior	
White interior	
Brushed Stainless Steel interior	
Mirrored interior	
- Black T-mold edging	
- White T-mold edging	
- Stainless Steel T-mold edging	
1" black McCue impact bumper strip applied to the outside of the end panel	
Other McCue impact bumper strip colors available upon request	

## MISCELLANEOUS

Roll-down thermal night curtain	
Eliminate 1 shelf level	
Rear venting kit for wall installation	

## ADDITIONAL FEATURES:

- Designed to maintain product temperature of 38-41°F with a maximum ambient atmosphere of 75°F/55% Humidity
- Hot gas condensate evaporation system
- ETL Listed and Sanitation certified to NSF 7
- 2 Year Parts & Labour Warranty
- Rear air intake, front discharge. Avoid any obstructions in these areas. A rear venting kit (for narrower width units) is available to install the display against a wall or where the back is obstructed

# SQUARE GLASS COMBINATION SERVICE/ SELF-SERVICE DISPLAY

REFRIGERATED

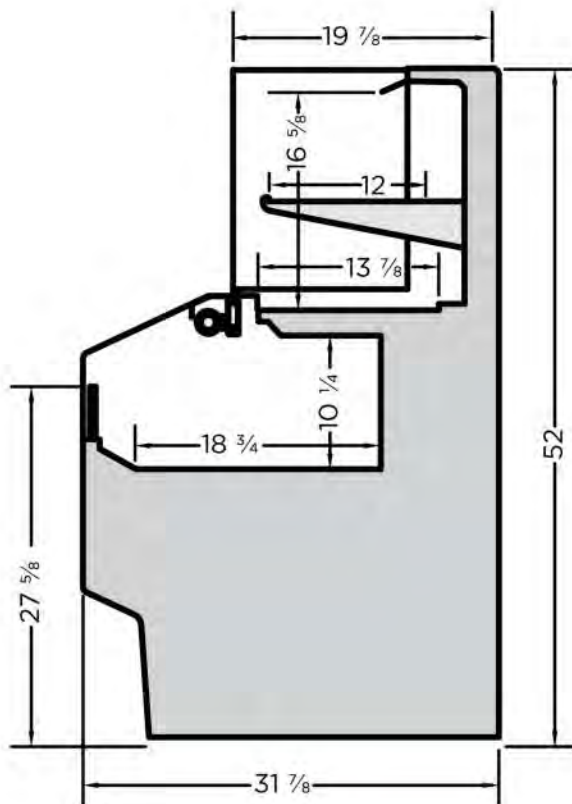



MODEL	LENGTH
ST-SSS-38-52	40 1/4"
ST-SSS-48-52	49 7/8"

## FEATURES:

- Outfitted with a sliding baffle between the upper and lower levels to allow the upper section to be used for either refrigerated or dry merchandising
- 3 interior finishes available
- Many exterior colors, patterns and wood grain finishes available
- R-134A self-contained refrigeration
- 1 upper adjustable tempered shelf with integrated LED lighting
- Unique all square glass top display area
- Removable base deck panels for easy cleaning and service
- LED lighting attached to the top ledge of the service and self-service display
- Thermal rear sliding doors at the back of the top service display
- Many options available. Refer to the options schedule on next page

## SUGGESTED APPLICATIONS:

-  Bakery
-  Cafe

Note: Information and specifications may change due to engineering improvements.



# SQUARE GLASS COMBINATION SERVICE/SERVICE DISPLAY

REFRIGERATED

## ELECTRICAL SPECS

MODEL	LENGTH	VOLTS	AMPS	NEMA	
ST-SSS-38-52	40 ¼"	115	11.6	5-15P	
ST-SSS-48-52	49 7/8"	115	11.9	5-15P	

## INTERIOR FINISH

Brushed Stainless Steel base inlay with textured black shelf standards and shelf supports	
Textured Black	
Textured White	

## EXTERIOR FINISHES

Category "A" laminate finish: <b>A-</b> ____	
Category "B" laminate finish: <b>B-</b> ____	
Other custom laminate specs:	
Brushed Stainless Steel	
Oak Veneer Plywood	
- Vertical grain direction	
- Horizontal grain direction	
Birch/Maple Veneer Plywood	
- Vertical grain direction	
- Horizontal grain direction	
Clear Finish applied to veneer	
Stain Finish Choice _____	
1" black McCue impact bumper strip applied to the front of the display	
Other McCue impact bumper strip colors Available upon request	

## END PANELS

Solid	
- LH (visualized from the front)	
- RH (visualized from the front)	
Interior laminate the same as exterior	
Black interior	
White interior	
Brushed Stainless Steel interior	
Mirrored interior	
- Black T-mold edging	
- White T-mold edging	
- Stainless Steel T-mold edging	
1" black McCue impact bumper strip applied to the outside of the end panel	
Other McCue impact bumper strip colors available upon request	

## MISCELLANEOUS

Roll-down thermal night curtain	
Eliminate 1 shelf level	

## ADDITIONAL FEATURES:

- Designed to maintain product temperature of 38-41°F with a maximum ambient atmosphere of 75°F/55% Humidity
- Hot gas condensate evaporation system
- ETL Listed and Sanitation certified to NSF 7
- 2 Year Parts & Labour Warranty
- Rear air intake, front discharge. Avoid any obstructions in these areas. A rear venting kit (for narrower width units) is available to install the display against a wall or where the back is obstructed